

Three Phase Inverter

Omniksol-5k-TL2-3P/6k/8k/9k/10k-TL2



Product features

Features

- Standard 10 years warranty, 5-15 years optional
- Built-in GPRS as option
- Built-in Wifi as option
- External Inductor
- Smaller and lighter, only 22kg
- High performance DSP for algorithm control
- VDE-AR-N 4105 certification
- New topology design
- Dual MPPT design
- IP65 waterproof and dustproof level
- Multi-button touch interface
- LCD screen visible at night
- Have anti-shading function

Advantages

- Longer life cycle
- Plug and play
- Free monitoring through our webportal
- Very lower internal temperature
- Easy transportation and installation
- Faster CPU speed
- Adjustable active and reactive power
- Maximum conversion efficiency up to 97.6%, Euro up to 96.8%
- More flexible system design
- Maximized system profit
- User friendly operation
- 24 hour operation data readable on screen
- Suitable to complex installation environment

Benefits

- More stable and reliable
- No commissioning work to get real-time remote monitoring
- More convenient monitoring solution without any charge
- Longer life cycle
- Saving storage and installation space
- Higher inverter control accuracy
- Meet the latest certification and regulations
- Increase generating capacity
- Increase system payback ability
- Fit in various installation environments
- Easy to operate
- Real-time operating condition accessible
- Increase the electricity generation of the system in shading environment

Block Diagram

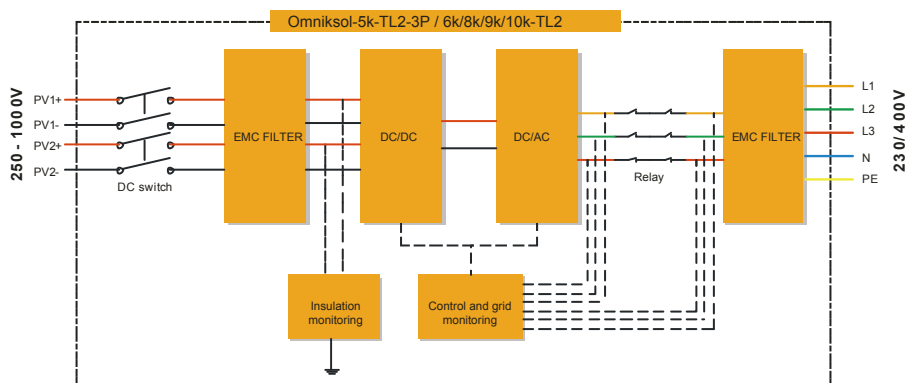

Technical Date

Omniksol-5k-TL2-3P/6k/8k/9k/10k-TL2

Type	Omniksol-5k-TL2-3P	Omniksol-6k-TL2	Omniksol-8k-TL2	Omniksol-9k-TL2	Omniksol-10k-TL2
Input (DC)					
Max. PV Power	5150W	6150W	8200W	9000W	10000W
Max DC Voltage	1000V	1000V	1000V	1000V	1000V
Nominal DC Voltage	640V	640V	640V	640V	640V
Operating MPPT Voltage Range	150-800V	150-800V	150-800V	150-800V	150-800V
MPPT Voltage Range at Nominal Power	260-800V	280-800V	360-800V	380-800V	380-800V
Start up DC Voltage	250V	250V	250V	250V	250V
Turn off DC Voltage	150V	150V	150V	150V	150V
Max. DC Current (A/B)	11A/11A	11A/11A	14A/14A	14A/14A	14A/14A
Max. Short Circuit Current for each MPPT	16A/16A	16A/16A	20A/20A	20A/20A	20A/20A
Number of MPP trackers	2	2	2	2	2
Max. Input Power for each MPPT*	5150W*	4000W	5000W	5000W	5000W
Number of DC Connection	A:2/B:2	A:2/B:2	A:2/B:2	A:2/B:2	A:2/B:2
DC Connection Type	MC4 connector	MC4 connector	MC4 connector	MC4 connector	MC4 connector
Output (AC)					
Max. AC Apparent Power	5000VA	6000VA	8000VA	8100VA	8200VA
Nominal AC Power (cos phi = 1)	5000W	6000W	8000W	8100W	8200W
Nominal AC Current	7.2A	8.7A	11.6A	11.7A	11.9A
Nominal AC Voltage	3/N/PE; 220/380V	3/N/PE; 220/380V	3/N/PE; 220/380V	3/N/PE; 220/380V	3/N/PE; 220/380V
	3/N/PE; 230/400V	3/N/PE; 230/400V	3/N/PE; 230/400V	3/N/PE; 230/400V	3/N/PE; 230/400V
	3/N/PE; 240/415V	3/N/PE; 240/415V	3/N/PE; 240/415V	3/N/PE; 240/415V	3/N/PE; 240/415V
Nominal Grid Frequency	50Hz/60Hz	50Hz/60Hz	50Hz/60Hz	50Hz/60Hz	50Hz/60Hz
Max. AC Current	8.8A	10.7A	13.6A	13.8A	13.9A
Grid Voltage Range**	185-276V	185-276V	185-276V	185-276V	185-276V
Grid Frequency Range**	45-55Hz/55-65Hz	45-55Hz/55-65Hz	45-55Hz/55-65Hz	45-55Hz/55-65Hz	45-55Hz/55-65Hz
Power Factor	0.9 capacitive...0.9 inductive				
Total Harmonic Distortion (THD)	<2%	<2%	<2%	<2%	<2%
Feed in Starting Power	30W	30W	30W	30W	30W
Night time Power Consumption	<1W	<1W	<1W	<1W	<1W
Standby Consumption	<10W	<10W	<10W	<10W	<10W
AC Connection Type	Plug-in connector	Plug-in connector	Plug-in connector	Plug-in connector	Plug-in connector
Efficiency					
Max. Efficiency	97.6%	97.6%	97.6%	97.6%	97.6%
Euro Efficiency	96.8%	96.8%	96.8%	96.8%	96.8%
MPPT Efficiency	99.9%	99.9%	99.9%	99.9%	99.9%
Safety and Protection					
DC Insulation Monitoring	Yes				
DC Switch	Optional				
Residual Current Monitoring Unit (RCMU)	Integrated				
Grid Monitoring with Anti-islanding	Yes				
Electricity Fuse Protection	Yes				
Protection Class	I (According to IEC 62103)				
Overvoltage Category	III(According to IEC 62109-1)				
Reference Standard					
Safety Standard	EN 62109, AS/NZS 3100				
EMC Standard	EN 61000-6-1, EN 61000-6-2, EN 61000-6-3, EN 61000-6-4, EN 61000-3-2, EN 61000-3-3				
Grid Standard	VDE-AR-N4105, VDE-0126-1-1, G83/1, EN 50438, RD1699, CEI 0-21, AS4777, C10/C11				
Physical Structure					
Dimensions (WxHxD)	352x421x172.5mm				
Weight	22kg				
Environmental Protection Rating	IP 65 (According to IEC 60529)				
Cooling Concept	Natural convection				
Mounting Information	Wall bracket				
General Data					
Operating Temperature Range	-25°C to +60°C(derating above 45°C)				
Relative Humidity	0% to 98%, no condensation				
Max. Altitude (above sea level)	2000m				
Noise Level	<40dB				
Isolation Type	Transformerless				
Display	20 x 4 LCD (800x480 TFT Graphic Display optional)				
Data Communication Interfaces	RS485(WiFi, GPRS optional)				
Computer Communication	USB				
Standard Warranty	10 Years (5 -15 years optional)				



*The AC voltage and frequency range may vary depending on specific country grid